



## CENTRIFUGES CATALOG

**OPTIKA<sup>®</sup>**  
I T A L Y

Practical Solutions for Sample Separation



## CONTENTS

<b>Selection Guide</b>	<b>6</b>
<b>Microcentrifuges</b>	<b>11</b>
OT-mini 6	12
OT-1312	14
OT-M15S	16
OT-M15R	18
OT-1848R	20
<b>Multi-purpose Centrifuges</b>	<b>23</b>
OT-1248 / OT-1248R / OT-1580 / OT-1580R	24
OT-1696R II	33
<b>High Speed, High Capacity, Floor standing Centrifuges</b>	<b>39</b>
OT-S12R / OT-S22R	40
<b>Low Speed Centrifuges</b>	<b>47</b>
OT-T04	48
OT-T04B / OT-T05R	50
<b>Clinical Use Centrifuges IVDR</b>	<b>56</b>
GZ-416	57

# Elevate Your Daily Lab Routine

## QUALITY EXCELLENCE

In-house manufacturing of all the key components, including all metalwork, rotors, and motors, within our own ISO 13485 and 9001 certified facilities allows us to maintain stringent quality control over every aspect of production, ensuring that each centrifuge meet high standards. By overseeing the process of producing centrifuges from start to finish, we embody our dedication to excellence in quality.



## SAFETY FIRST

Centrifuges are crucial, daily-use instruments operating at high RPMs, we put user safety before anything. By adhering to international CE regulations, we ensure comprehensive electrical and mechanical safety in every OPTIKA centrifuge. Additionally, our selectable third-party certified aerosol-tight rotors and buckets are designed to prevent the leakage of hazardous samples, offering an extra layer of protection for users.



---

### ENHANCE YOUR RESULT

OPTIKA's refrigerated centrifuges are, equipped with advanced cooling systems from leading global brands. Essential for temperature-sensitive samples, these centrifuges preserve the integrity of live cells and prevent protein denaturation, ensuring reliable research outcomes.

Designed for durability and continual operation, they meet the demands of high-throughput labs and improve workflow efficiency

---

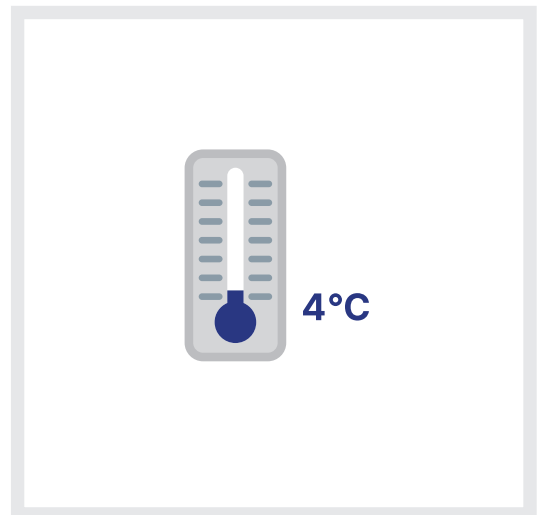







---

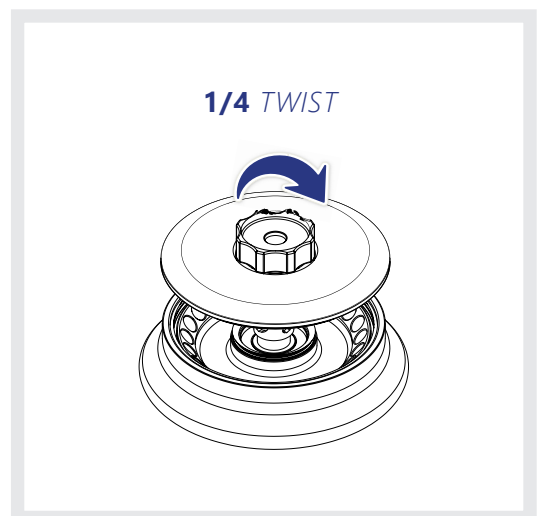



### DESIGNED FOR EFFICIENCY

Microcentrifuge models are equipped with an easy lock mechanism that secures the rotor with a simple quarter twist, and the 1696R II model features a Snap-On bucket lid. These user-friendly designs minimize wrist strain, making them productive for highthroughput laboratories engaged in repetitive work.

---



	Microcentrifuges				
					
	<b>OT-mini 6</b>	<b>OT-1312</b>	<b>OT-M15S</b>	<b>OT-M15R</b>	<b>OT-1848R</b>
Max. RPM / Fixed angle	6,500 rpm	13,500 rpm	15,000 rpm	15,000 rpm	18,000 rpm
Max. RPM / Swing-out	-	-	-	-	13,000 rpm
Max. RCF / Fixed angle	2,234 xg (1.5/2.0 mL tube) 1,412 xg (PCR strip)	12,300 x g	21,206 xg	21,583 xg	30,356 x g
Max. RCF / Swing-out	-	-	-	-	16,438 x g
Max. capacity / Fixed angle	6 x 1.5/2.0 mL 2 PCR strips	12 x 1.5 / 2.0 mL	24 x 1.5/2.0 mL	24 x 1.5/2.0 mL	48 x 1.5 / 2.0 mL
Max. capacity / Swing-out	-	-	-	-	6 x 4 x 1.5 / 2.0 mL
Settable Min. RPM	-	1,200	400	400	300
Speed accuracy	±10%	±2%	±2%	±2%	±2%
RCF/RPM conversion	±10%	Yes	Yes	Yes	Yes
Temperature range (°C)	-	-	-	-10°C to 40°C	-12°C to 40°C
FAST cool button	-	-	-	Yes	Yes
Key lock function	-	-	-	-	Yes
Time control	Selectable, Short (12 sec) or Continuous (15 min)	Pulse or timed ≤30 min	Pulse, Timed < 100 min or continuous		Pulse, timed < 10 hr or continuous
Time counting	-	From starting	Selectable, at set speed or from starting		
Noise level (dependent on rotor)	≤56 dB	≤56 dB	< 60 dB	< 60 dB	≤60 dB
ACC/DEC ramps	-	-	9/10	9/10	9/10
Program memory	-	-	10	10	100
Rotor identification	-	-	N / Dedicated rotor	Manual	Automatic
Imbalance cutout	-	-	Yes	Yes	Yes
Safety lid lock	-	Yes	Yes	Yes	Yes
Motorized door open & close	-	-	-	-	Yes
Power supply (V/Hz)	100-230V, 50/60Hz	220-230V~, 50/60Hz (110V 60Hz optional)			
Power Requirement	7W	110VA	500VA	2.5 kVA	2.0 KVA
Dimension (W x D x H, mm)	150 x 150 x 103	208 x 245 x 145	293 x 380 x 242	285 x 593 x 281	380 x 654 x 312
Weight without rotor	650 g	4.4 kg	15 kg	33 kg	53.5 kg
Cat. No.	OT-mini 6	OT-1312	OT-M15S	OT-M15R	OT-1848R

Multi-purpose Centrifuges				
				
<b>OT-1248</b>	<b>OT-1248R</b>	<b>OT-1580</b>	<b>OT-1580R</b>	<b>OT-1696R II</b>
12,000 rpm	12,000 rpm	15,000 rpm	15,000 rpm	16,000 rpm
5,000 rpm	5,000 rpm	5,000 rpm	5,000 rpm	5,000 rpm
16,582 x g	16,582 x g	24,249 x g	25,910 x g	27,991 xg
5,394 x g	5,394 x g	5,394 x g	5,394 x g	5,394 xg
6 x 85mL	6 x 85mL	6 x 85mL	6 x 250 mL	6 x 250 mL
4 x 250 mL	4 x 250 mL	4 x 750 mL	4 x 750 mL	4 x 1,000 mL
500	500	500	500	300
±2%	±2%	±2%	±2%	±0.1%
Yes	Yes	Yes	Yes	Yes
	-20°C to 40°C		-10°C to 40°C	-11°C to 40°C
	Yes		Yes	Yes
Yes	Yes	Yes	Yes	Yes
Pulse, Timed < 100 min or continuous	Pulse, Timed < 10 hr or continuous	Pulse, timed < 100 min or continuous	Pulse, Timed < 10 hr or continuous	Pulse, Timed < 10 hr or continuous
Selectable, at set speed or from starting				
≤60 dB	≤60 dB	≤60 dB	≤60 dB	<70 dB
9/10	9/10	9/10	9/10	9/10
100	100	100	100	100 (3 Direct Program Save/Call button)
Automatic	Automatic	Automatic	Automatic	Automatic
Yes	Yes	Yes	Yes	Yes
Yes	Yes	Yes	Yes	Yes
Yes	Yes	Yes	Yes	Yes
220-230V~, 50/60Hz (110V 60Hz optional)				220-230V, 60Hz (220~230V, 50Hz, 110V 60Hz optional)
900VA	2.5KVA	1.5KVA	2.5KVA	2KVA
475 x 561 x 330	655 x 620 x 357	540 x 650 x 380	770 x 650 x 390	775 x 695 x 395
40 kg	78 kg	57 kg	93 kg	132
OT-1248	OT-1248R	OT-1580	OT-1580R	OT-1696R II

	High Speed, High Capacity, Floor standing Centrifuges		Low Speed Centrifuges			Clinical Use Centrifuges
						
	<b>OT-S12R</b>	<b>OT-S22R</b>	<b>OT-T04</b>	<b>OT-T04B</b>	<b>OT-T05R</b>	<b>GZ-416</b>
Max. RPM / Fixed angle	12,000 rpm	22,000 rpm	4,000 rpm	4,000 rpm	5,000 rpm	4,000 rpm
Max. RPM / Swing-out	-	-	-	4,000 rpm	5,000 rpm	4,000 rpm
Max. RCF / Fixed angle	22,265 xg	52,001 xg	2,075 x g	2,773 x g	3,983 x g	2,700 x g
Max. RCF / Swing-out	-	-	-	2,774 x g	4,218 x g	2,826 x g
Max. capacity / Fixed angle	6 x 1,000 mL	4 x 1,000 mL	12 x vacuum tube	10 x 50 mL	10 x 50 mL	16 x 15 mL, 10 x 50 mL
Max. capacity / Swing-out	-	-	-	4 x 100 mL	4 x 100 mL	4 x 100 mL
Settable Min. RPM	400	400	500	400	400	500
Settable Min. RPM	±2%	±2%	±2%	±2%	±2%	±2%
RCF/RPM conversion	Yes	Yes	Yes	Yes	Yes	Yes
Temperature range (°C)	-10°C to 40°C	-10°C to 40°C	-	-	-10°C to 40°C	-
FAST cool button	Yes	Yes	-	-	Yes	-
Key lock function	Yes	Yes	-	Yes	Yes	-
Time control	Pulse, Timed < 10 hr or continuous		Pulse, timed < 100 min or continuous	Pulse, Timed < 10 hr or continuous		Pulse, timed < 100 min or continuous
Time counting	Selectable, At Set Speed Or From Starting		From Starting	Selectable, at set speed or from starting		From Starting
Noise level (dependent on rotor)	≤ 65 dB	≤ 65 dB	< 52 dB	< 60 dB	< 60 dB	< 52 dB
ACC/DEC ramps	10/10 steps	10/11 steps	-	9/10 steps	9/10 steps	-
Program memory	100	100	30	100	100	10
Rotor identification	Automatic	Automatic	-	manual	Automatic	-
Imbalance cutout	Yes	Yes	Yes	Yes	Yes	Yes
Safety lid lock	Yes	Yes	Yes	Yes	Yes	Yes
Motorized door open & close	Yes	Yes	-	-	-	-
Power supply (V/Hz)	220-230V~, 50/60Hz (110V 60Hz optional)	220-230V, 60Hz (220~230V, 50Hz, 110V 60Hz optional)	210~240 V, 50/60Hz (110V 60Hz optional)			230V, 50Hz (220~230V, 60/50Hz, 110V optional)
Power Requirement (VA)	3.0 kW	4.6 kVA	140VA	340VA	900 VA	340VA
Dimension (W x D x H, mm)	668 x 800 x 891/805	681 x 795 x 920	296 x 408 x 213	375 x 506 x 265	584 x 554 x 313	375 x 335 x 317
Weight without rotor	230 kg	247 kg	15 kg	25.7 kg	65.7 kg	19.5 kg
Cat. No.	OT-S12R	OT-S22R	OT-T04	OT-T04B	OT-T05R	GZ-416(IVD)



**RPM/RCF Conversion**

One touch conversion of RPM and g-force.



**Fast Cool**

Pre-cooling to 4°C before running for temperature-sensitive samples.



**Rotor ID**

Limit the setting of RPM above the maximum by automatic rotor identification.



**Up to 100 or 10 Program Memory**

Enables to store different parameter settings.



**Motorized Lid Mechanics**

Prevents unintentional opening of the lid and makes the lid easy to close.



**Short Spin (Pulse)**

Separate button for pulse function.



**Lid Drop Protection**

Provides easy and safe loading and unloading of sample.



**At Set Speed Time Mode**

Time counting button from set speed or starting.



**Automatic Lid Opening**

Visualizes the end of the run by lid opening.



**ACC/DEC Rate Control**

Different speed rate settings of acceleration (9 steps) / deceleration. (10 steps)



**Bio-Safe Accessories**

Certified aerosol tightness for safe centrifugation of hazardous sample.



**Variety of Rotors, Buckets, and Adaptors**

Wide range of rotors, buckets, and adaptors for various applications.



**Intuitive Control Pad with Numeric Input**

Easy setting and editing of run parameters.user environments.



**Soft Touch Keypad**

Sensible for both hand and glove.



# Microcentrifuges

**OT-mini 6**



**OT-1312**



**OT-M15S**



**OT- M15R**



**OT- 1848R**



# OT-mini 6

## Micro Centrifuge

The OT-mini 6 centrifuge is a simple minifuge for quick spin-downs by closing the centrifuge lid



### Features

- Supplied with rotors A2.0-6 & A0.2-16
- Electro sensitive non-contacting lid sensor
- Safety stop by opening the lid

### Technical Specifications

	OT-mini 6
Max. RPM	6,500 rpm
Max. RCF	2,234 xg (1.5/2.0 mL tube) 1,412 xg (PCR strip)
Max. capacity	6 x 1.5/2.0 ml 2 PCR strips
Speed accuracy	±10%
Time control	Selectable, Short (12 sec) or Continuous (15 min)
Noise level (dependent on rotor)	≤56 dB
Safety lid lock	Yes
Power supply (V/Hz)	100-230V, 50/60Hz
Power Requirement (VA)	7W
Dimension (W x D x H, mm)	150 x 150 x 103
Weight without rotor	650 g
Cat. No.	OT-mini 6

## Fixed Angle Rotor

**A2.0-6**

- Capacity : 6 x1.5/2.0 mL
- Max. RPM : 6,500
- Max. RCF : 1,710 xg
- Supplied with centrifuge



## Adaptors

Tube type (mL)	Max. RCF (xg)	Adaptor Cat. No.
0.5	1,710	TR0.5(2)
0.2	1,379	TR0.2(2)

## PCR Rotor

**A0.2-16**

- Capacity : 16 x 0.2 mL
- Max. RPM : 6,500
- Max. RCF : 1,412 xg
- Supplied with centrifuge



# OT-1312

## Micro Centrifuge

The OT-1312 centrifuge is a personal minifuge for individual workstations



### Features

- Supplied with an 12 x 2.0 mL, autoclavable, anodized aluminum rotor and click-seal plastic lid.
- Automatic rpm/rcf conversion
- Automatic lid opening function, at the completion of a run, serves to both indicate the end of the process and to prevent sample warming
- Lid drop protection design allows easiness and safety when loading or unloading samples.

### Technical Specifications

	OT-1312
Max. RPM	13,500 rpm
Max. RCF	12,300 x g
Max. capacity	12 x 1.5 / 2.0 mL
Settable Min. RPM	1,200
RCF/RPM conversion	Yes
Time control	Pulse or timed ≤30 min
Time counting	From starting
Noise level (dependent on rotor)	≤56 dB
Safety lid lock	Yes
Power supply (V/Hz)	220-230V~, 50/60Hz (110V 60Hz optional)
Power Requirement (VA)	110VA
Dimension (W x D x H, mm)	208 x 245 x 145
Weight without rotor	4.4 kg
Cat. No.	OT-1312

## Fixed Angle Rotor GRF-m2.0-12

- Capacity : 12 x 1.5 / 2.0 mL
- Max. RPM : 13,500
- Max. RCF : 12,300 xg
- Autoclaveable PP snap-fit lid rotor
- Supplied with centrifuge



### Adaptors

Tube type (mL)	Max. RCF (xg)	Adaptor Cat. No.
0.5	10,290	GAS-m0.5(2)
0.2	8,863	GAS-m0.2(2)

## Fixed Angle Rotor GRF-m2.0-12-b

- Capacity : 12 x 1.5 / 2.0 mL
- Max. RPM : 13,500
- Max. RCF : 12,300 xg
- Anodized aluminum screw lid rotor



### Adaptors

Tube type (mL)	Max. RCF (xg)	Adaptor Cat. No.
0.5	10,290	GAS-m0.5(2)
0.2	8,863	GAS-m0.2(2)

## Fixed Angle Rotor GRF-m1.8-10

- Capacity : 10 x 1.8 mL Cryotube
- Max. RPM : 13,500
- Max. RCF : 12,300 xg
- Autoclaveable PP snap-fit lid rotor



## Angle Rotor GRA-s0.2-32

- Capacity : 4 x 8-Tube PCR strips, 32 x 0.2 mL
- Max. RPM : 6,000
- Max. RCF : 1,850 xg



# OT-M15S

## Micro Centrifuge

The OT-M15S is a compact microcentrifuge designed for routine molecular biology applications



### Features

- Supplied with an 24 x 2.0 mL, autoclavable, anodized aluminum rotor and click-seal plastic lid.
- Automatic rpm/rcf conversion
- Automatic lid opening function, at the completion of a run, serves to both indicate the end of the process and to prevent sample warming
- Selectable time mode of "at set SPEED" for counting running time only when reached the set speed
- A separate "PULSE" key for quick spin
- Lid drop protection design allows easiness and safety when loading or unloading samples.

### Technical Specifications

OT-M15S	
Max. RPM	15,000 rpm
Max. RCF	21,206 xg
Max. capacity	24 x 1.5/2.0 mL
Settable Min. RPM	400
RCF/RPM conversion	Yes
Time control	Pulse, Timed < 100 min or continuous
Time counting	Selectable, at set speed or from starting
Noise level (dependent on rotor)	< 60 dB
ACC/DEC ramps	9/10
Program memory	10
Rotor identification	N / Dedicated rotor
Imbalance cutout	Yes
Safety lid lock	Yes
Power supply (V/Hz)	220-230V~, 50/60Hz (110V 60Hz optional)
Power Requirement (VA)	500 VA
Dimension (W x D x H, mm)	293 x 380 x 242
Weight without rotor	15 kg
Cat. No.	OT-M15S

### Fixed Angle Rotor

## A2.0-MP-24

- Capacity : 24 x 1.5 / 2.0 mL
- Max. RPM : 15,000
- Max. RCF : 21,206 xg
- Autoclaveable PP snap-fit lid rotor
- Supplied with centrifuge



### Adaptors

Tube type (mL)	Max. RCF (xg)	Adaptor Cat. No.
0.5	18,363	TR0.5(2)
0.2	16,854	TR0.2(2)



# OT-M15R

## Micro Centrifuge

The OT-M15R is a general refrigerated microcentrifuge designed for routine molecular biology applications for temperature sensitive samples or back to back runs



Bio

### Features

- Bio-seal (Public Health England Porton Down) certified Easy-lock rotor for aerosol tight operation of harmful samples
- Automatic rpm/rcf conversion
- Compressor-off function when lid is open minimizes unnecessary cooling and frosting.
- Temperature range from -10°C to +40°C
- 'Fast cool' function, R.T. to 4°C in 5 minutes for fast start up of cooled samples
- Selectable time mode of "at set SPEED" for counting running time only when reached the set speed
- A separate "PULSE" key for quick spin
- Lid drop protection design allows easiness and safety when loading or unloading samples.

### Technical Specifications

OT-M15R	
Max. RPM	15,000 rpm
Max. RCF	21,583 xg
Max. capacity	24 x 1.5/2.0 mL
Settable Min. RPM	400
RCF/RPM conversion	Yes
Temperature range (°C)	-10°C to 40°C
FAST cool button	Yes
Time control	Pulse, Timed < 100 min or continuous
Time counting	Selectable, at set speed or from starting
Noise level (dependent on rotor)	< 60 dB

ACC/DEC ramps	9/10
Program memory	10
Rotor identification	Manual
Imbalance cutout	Yes
Safety lid lock	Yes
Power supply (V/Hz)	220-230V~, 50/60Hz (110V 60Hz optional)
Power Requirement (VA)	2.5 kVA
Dimension (W x D x H, mm)	285 x 593 x 281
Weight without rotor	33 kg
Cat. No.	OT-M15R

Fixed Angle Rotor

## GRE-M-m5.0-12

- Capacity : 12 x 5 mL Conical
- Max. RPM : 15,000
- Max. RCF : 22,967 xg
- Easy-lock feature



Fixed Angle Rotor

## AEB-2.0-24

- Capacity : 24 x 1.5 / 2.0 mL
- Max. RPM : 15,000
- Max. RCF : 21,206 xg
- Easy-lock, Bio-safe feature



### Adaptors

Tube type (mL)	Max. RCF (xg)	Adaptor Cat. No.
0.5	18,363	TR0.5(2)
0.2	16,854	TR0.2(2)

Fixed Angle Rotor

## AEB-0.2-32

- Capacity : 4 x 8-Tube PCR strips, 32 x 0.2 mL
- Max. RPM : 12,500
- Max. RCF : 9,852 xg
- Easy-lock, Bio-safe feature



# OT-1848R

## Micro Centrifuge

The OT-1848R is an extended throughput, refrigerated microcentrifuge engineered to accommodate up to 50 mL conical tubes, making it suitable for temperature-sensitive and high-throughput applications within limited benchtop space



### Features

- Bio-seal (Public Health England Porton Down) certified Easy-lock rotor for aerosol tight operation of harmful samples
- Automatic rpm/rcf conversion
- Compressor-off function when lid is open minimizes unnecessary cooling and frosting.
- Temperature range from -12°C to 40°C
- 'Fast cool' function, R.T. to 4°C in 5 minutes for fast start up of cooled samples
- Selectable time mode of "at set SPEED" for counting running time only when reached the set speed
- A separate "PULSE" key for quick spin
- Intuitive control interface with numeric input buttons allows easy setting and editing of running conditions.
- Key lock function helps the set parameters secured during operation.
- Lid drop protection design allows easiness and safety when loading or unloading samples.

**Technical Specifications**

OT-1848R	
Max. RPM / Fixed angle	18,000 rpm
Max. RPM / Swing-out	13,000 rpm
Max. RCF / Fixed angle	30,356 xg
Max. RCF / Swing-out	16,438 xg
Max. capacity / Fixed angle	48 x 1.5/2.0 mL
Max. capacity / Swing-out	6 x 4 x 1.5/2.0 mL
Settable Min. RPM	300
RCF/RPM conversion	Yes
Temperature range (°C)	-12°C to 40°C
FAST cool button	Yes
Key lock function	Yes
Time control	Pulse, timed < 10 hr or continuous
Time counting	Selectable, at set speed or from starting

Noise level (dependent on rotor)	≤60 dB
ACC/DEC ramps	9/10
Program memory	10
Rotor identification	Automatic
Imbalance cutout	Yes
Safety lid lock	Yes
Motorized door open & close	Yes
Power supply (V/Hz)	220-230V~, 50/60Hz (110V 60Hz optional)
Power Requirement (VA)	2.0 KVA
Dimension (W x D x H, mm)	380 x 654 x 312
Weight without rotor	53.5 kg
Cat. No.	OT-1848R

Fixed Angle Rotor  
**GRF-M-c50-8**

Capacity : 8 x 50 mL Conical  
Max. RPM : 8,500 / Max. RCF : 8,893 xg

**Adaptors**

Tube type (mL)	Max. RCF (xg)	Adaptor Cat. No.
50	8,651	GAS-50(c50)
30	8,595	GAS-30(c50)
25 conical	7,544	GAS-c25(c50)
15 conical	8,635	GAS-c15(c50)



Fixed Angle Rotor  
**GRF-M-c15-12**

- Capacity : 12 x 15 mL Conical
- Max. RPM : 8,500 / Max. RCF : 8,611 xg

**Adaptors**

Tube type (mL)	Max. RCF (xg)	Adaptor Cat. No.
14	7,843	GAS-14(c15)
5 conical	6,842	GAS-c5(c15)



Fixed Angle Rotor  
**GRE-M-m5.0-20**

- Capacity : 20 x 5 mL Conical
- Max. RPM : 13,000 / Max. RCF : 20,595 xg
- Easy-lock feature



Fixed Angle Rotor

## GRE-M-m2.0-48

- Capacity : 48 x 1.5 / 2.0 mL
- Max. RPM : 13,000 / Max. RCF :18,479 xg
- Easy-lock feature



Adaptors

Tube type (mL)	Max. RCF (xg)	Adaptor Cat. No.
0.5	16,532	GAS-m0.5(2)
0.2	15,210	GAS-m0.2(2)

Fixed Angle Rotor

## GREB-M-m2.0-24

- Capacity : 24 x 1.5 / 2.0 mL
- Max. RPM : 18,000 / Max. RCF : 30,536 xg
- Easy-lock, Bio-safe feature



Adaptors

Tube type (mL)	Max. RCF (xg)	Adaptor Cat. No.
0.5	26,443	GAS-m0.5(2)
0.2	24,270	GAS-m0.2(2)

Fixed Angle Rotor

## GRE-M-s0.2-64

- Capacity : 8 x 8-Tube PCR strips, 64 x 0.2 mL
- Max. RPM : 12,500
- Max. RCF : 11,722
- Easy-lock feature



Windshield, Swing-out Rotor

## GRD-M-m2.0-24

- Capacity : 24 x 1.5 / 2.0 mL
- Max. RPM : 13,000
- Max. RCF : 16,438 xg



Adaptors

Tube type (mL)	Max. RCF (xg)	Adaptor Cat. No.
0.5	14,737	GAS-m0.5(2)
0.2	13,226	GAS-m0.2(2)

Windshield, Swing-out Rotor

## GRD-M-mw-2

- Capacity : 2 x MTP
- Max. RPM : 6,100
- Max. RCF : 3,432 xg

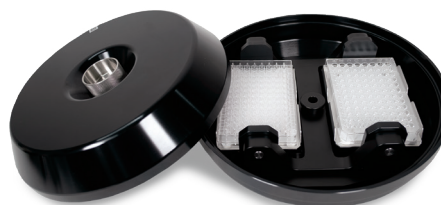

# Multi-purpose Centrifuges

**OT-1248**



**OT-1248R**



**OT-1580**



**OT-1580R**



**OT-1696R II**



# OT-1248 / OT-1248R / OT-1580 / OT-1580R

## Multi-purpose Centrifuges

The OT-1248 and OT-1580 series are multi-purpose centrifuges available in both air-ventilated and refrigerated models, offering high-speed performance up to 15,000 RPM with fixed-angle rotors.

While the medium-throughput OT-1248 models accommodate 4 x 250 mL swing-out buckets, the high-throughput OT-1580 models expand this capacity to 4 x 750 mL to meet diverse laboratory requirements.



R model

1248 / 1580

## Features

- Automatic RPM/RCF conversion and a dedicated "Pulse" key for quick spins facilitate efficient operation.
- Intuitive control interface with numeric input buttons allows for effortless setting and modification of running conditions.
- Key lock function ensures that set parameters remain secure during operation.
- Lid drop protection design provides enhanced safety and convenience during sample loading and unloading.
- Selectable "At set speed" time mode counts the run time only once the target speed is reached.
- Bio-seal screw-type buckets are available for aerosol-tight operation with hazardous samples. (1580, 1580R)
- Automatic lid opening at the completion of a run signals the end of the process and prevents sample warming. (1248, 1580)
- Integrated cooling system provides a temperature range of -20°C to 40°C (1248R) or -10°C to 40°C (1580R).
- "Fast Cool" function chills the chamber from room temperature to 4°C within 8 minutes for rapid startup. (1248R, 1580R)
- Compressor-off function when the lid is open minimizes unnecessary cooling and frosting. (1248R, 1580R)

## Technical Specifications

Model Name	OT-1248	OT-1248R	OT-1580	OT-1580R
Max. RPM / Fixed angle	12,000 rpm		15,000 rpm	
Max. RPM / Swing-out	5,000 rpm		5,000 rpm	
Max. RCF / Fixed angle	16,582 x g		24,249 x g	25,910 x g
Max. RCF / Swing-out	5,394 x g		5,394 x g	
Max. capacity / Fixed angle	6 x 85 mL		6 x 85 mL	6 x 250 mL
Max. capacity / Swing-out	4 x 250 mL		4 x 750 mL	
Settable Min. RPM	500			
RCF/RPM conversion	Yes			
Temperature range (°C)	-	-20°C to 40°C	-	-10°C to 40°C
FAST cool button	-	Yes	-	Yes
Key lock function	Yes			
Time control	Pulse, Timed < 100 min or continuous	Pulse, Timed < 10 hr or continuous	Pulse, timed < 100 min or continuous	Pulse, Timed < 10 hr or continuous
Time counting	Selectable, at set speed or from starting			
Noise level (dependent on rotor)	≤60 dB			
ACC/DEC ramps	9/10			
Program memory	100			
Rotor identification	Automatic			
Imbalance cutout	Yes			
Safety lid lock	Yes			
Motorized door open & close	Yes			
Power supply (V/Hz)	220-230V~, 50/60Hz (110V 60Hz optional)			
Power Requirement (VA)	900VA	2.5KVA	1.5KVA	2.5KVA
Dimension (W x D x H, mm)	475 x 561 x 330	655 x 620 x 357	540 x 650 x 380	770 x 650 x 390
Weight without rotor	40 kg	78 kg	57 kg	93 kg
Cat. No.	OT-1248	OT-1248R	OT-1580	OT-1580R

Fixed Angle Rotor

**GRF-G-250-6** 1580R Only

- Capacity : 6 x 250 mL
- Max. RPM : 8,500
- Max. RCF : 8,893 xg



Adaptors

Tube type (mL)	Max. capacity per Rotor	Max. RCF (xg)	Adaptor Cat. No.
100	6	8,586	GAS-100(250)
85	6	8,443	GAS-85(250)
50 conical (Skirt)	6	8,622	GAS-sc50(250)
50 conical	6	8,193	GAS-c50(250)
50	12	8,264	GAM-50-2(250)
30	18	9,159	GAM-30-3(250)

Tube type (mL)	Max. capacity per Rotor	Max. RCF (xg)	Adaptor Cat. No.
25 conical	6	8,228	GAS-c25(250)
15 conical	24	9,051	GAM-c15-4 (250)
15	24	9,230	GAM-15-4(250)
Φ16 x 100 mm VT	42	9,373	GAM-10-7(250)
Φ13 x 75~100mm VT	48	9,373	GAM-7-8(250)
5 conical	24	9,051	GAM-c5-4(250)
1.5 / 2.0	54	9,230	GAM-m2.0-9(250)

Fixed Angle Rotor

**GRF-G-85-6**

- Capacity : 6 x 85 mL
- Max. RPM / RCF  
10,000 / 12,298 xg (1248 / 1248R / 1580)  
12,000 / 17,709 xg (1580R)



Adaptors

Tube type (mL)	Max. RCF (xg)		Adaptor Cat. No.
	1248 / 1248R / 1580	1580R	
50 conical	11,404	16,421	GAS-c50(85)
50	11,627	16,743	GAS-50(85)
30	11,460	16,502	GAS-30(85)
25 conical	9,727	14,006	GAS-c25(85)
15 conical	11,292	16,260	GAS-c15(85)
15	11,515	16,582	GAS-15(85)

Fixed Angle Rotor  
**GRF-G-50-8**

- Capacity : 8 x 50 mL
- Max. RPM / RCF  
12,000 / 16,582 xg (1248 / 1248R / 1580)  
15,000 / 25,910 xg (1580R)

Adaptors

Tube type (mL)	Max. RCF (xg)		Adaptor Cat. No.
	1248 / 1248R / 1580	1580R	
30	15,520	24,249	GAS-30(50)
25 conical	13,040	20,376	GAS-c25(50)
15 conical	15,455	24,149	GAS-c15(50)
15	15,053	23,520	GAS-15(50)



Fixed Angle Rotor  
**GRF-G-c50-8**

- Capacity : 8 x 50 mL Conical
- Max. RPM / RCF  
10,000 / 12,298 xg (1248 / 1248R / 1580)  
13,000 / 20,784 xg (1580R)

Adaptors

Tube type (mL)	Max. RCF (xg)		Adaptor Cat. No.
	1248 / 1248R / 1580	1580R	
50	11,996	20,273	GAS-50(c50)
30	11,896	20,103	GAS-30(c50)
25 conical	10,520	17,779	GAS-c25(c50)
15 conical	11,761	19,877	GAS-c15(c50)



Fixed Angle Rotor  
**GRF-G-c15-12**

- Capacity : 12 x 15 mL Conical
- Max. RPM / RCF  
12,000 / 16,582 xg (1248 / 1248R / 1580)  
15,000 / 25,910 xg (1580R)

Adaptors

Tube type (mL)	Max. RCF (xg)		Adaptor Cat. No.
	1248 / 1248R / 1580	1580R	
5 conical	12,203	19,067	GAS-c5(c15)



Fixed Angle Rotor  
**GRF-G-m2.0-30**

- Max. Capacity : 30 x 1.5 / 2.0 mL
- Max. RPM / RCF  
12,000 / 15,520 xg (1248 / 1248R)  
15,000 / 24,249 xg (1580 / 1580R)



Adaptors

Tube type (mL)	Max. RCF (xg)		Adaptor Cat. No.
	1248 / 1248R	1580 / 1580R	
0.5	13,835	21,633	GAS-m0.5(2)
0.2	12,718	19,872	GAS-m0.2(2)

Angle Rotor  
**GRA-G-15-24**

- Max. Capacity : 24 x Vacuum tube or 15 mL
- Max. RPM : 4,000
- Max. RCF : 3,134 xg

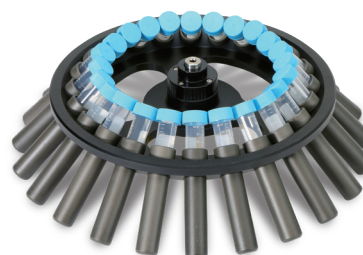

Adaptors

Tube type (mL)	Max. RCF (xg)	Adaptor Cat. No.
14	2,882	GAS-14(f15)
5	2,503	GAS-c5(f15)
Φ13 x 100 mm VT	2,990	GAS-5(f15)
Φ13 x 75 mm VT	2,776	GAS-3(f15)

Swing-out Rotor

**GRS-G-r750-4** 1580 / 1580R Only

- Capacity : 4 buckets
- Max. RPM : 3,600
- Max. RCF : 2,898 xg



750 mL Rectangular Bucket

**GLB-r750-r750**

- Capacity: 1EA adaptor
- Max. RPM : 3,600
- Max. RCF : 2,898 xg
- Hole bottom type : Flat

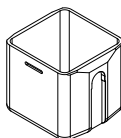

Microplate Bucket

**GLP-mw-r750**

- Max. Capacity: 4 x MTP / 1 x DWP
- Max. Load : 330 g
- Max. RPM : 3,000
- Max. RCF : 1,726 xg

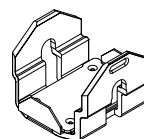

Adaptors

Tube type (mL)	Max. capacity per Rotor	Max. RCF (xg)	Adaptor Cat. No.
500	4	2,847	GAS-500(r750)
500 conical	4	2,883	GAS-c500(r750)
250 conical	4	2,883	GAS-c250(r750)
250	4	2,840	GAS-250(r750)
50 conical	20	3,869	GAM-c50-5(r750)
25 conical	20	2,869	GAM-c50-5(r750)
50	32	2,854	GAM-50-8(r750)
15 conical	64	2,869	GAM-c15-16(r750)
5 conical	64	2,869	GAM-c15-16(r750)
15	80	2,854	GAM-15-20(r750)
14	32	2,854	GAM-15-20(r750)
Φ16 x 100 mm VT	80	2,854	GAM-15-20(r750)
Φ13 x 100 mm VT	120	2,854	GAM-5-30(r750)
Φ13 x 75 mm VT	120	2,854	GAM-5-30(r750)

Swing-out Rotor

**GRS-G-750-4** 1580 / 1580R Only

- Capacity : 4 Buckets
- Max. RPM : 4,000
- Max. RCF : 2,898 xg



750 mL Bio-safe Bucket with Screw Type Cap

**GLBB-b750-750**

- Capacity: 750 mL bottle or 1EA adaptor
- Max. RPM : 4,000
- Max. RCF : 3,667 xg
- Hole bottom type : Flat

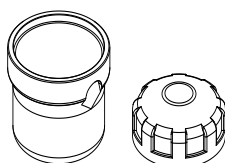

Microplate Bucket

**GLP-mw-750**

- Max. Capacity: 4 x MTP / 1 x DWP
- Max. Load : 330 g
- Max. RPM : 3,000
- Max. RCF : 1,726 xg

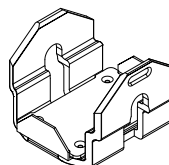

Adaptors

Tube type (mL)	Max. capacity per Rotor	Max. RCF (xg)	Adaptor Cat. No.
500	4	3,604	GAS-500(750)*
500 conical	4	3,667	GAS-c500(750)*
250 conical	4	3,667	GAS-c250(750)*
250	4	3,595	GAS-250(750)
50 conical	20	3,667	GAM-c50-5(750)
25 conical	28	3,595	GAM-50-7(750)
50	56	3,667	GAM-c15-14(750)
15 conical	40	3,667	GAM-c15-14(750)
5 conical	76	3,595	GAM-15-19(750)
15	28	3,595	GAM-15-19(750)
14	84	3,595	GAM-10-21(750)
Φ16 x 100 mm VT	96	3,595	GAM-5-24(750)
Φ13 x 100 mm VT	96	3,595	GAM-5-24(750)
Φ13 x 75 mm VT	120	2,854	GAM-5-30(r750)

\* Cannot use cap sealing

High Speed Microplate Bucket

**GLP-mw-750D**

- Max. Capacity: 4 x MTP / 1 x DWP
- Max. Load : 330 g
- Max. RPM : 3,600
- Max. RCF : 2,485 xg

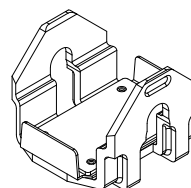

## Swing-out Rotor GRS-G-r250-4

- Capacity : 4 Buckets
- Max. RPM : 4,000
- Max. RCF : 2,737 xg



250 mL Rectangular Bucket

### GLB-r250-r250

- Capacity: 1EA adaptor
- Max. RPM : 4,000
- Max. RCF : 2,737 xg
- Hole bottom type : Flat

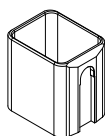

Microplate Bucket

### GLP-mw-r250

- Max. Capacity: 4 x MTP / 1 x DWP
- Max. Load : 330 g
- Max. RPM : 4,000
- Max. RCF : 2,737 xg

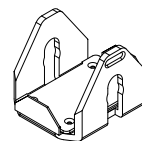

### Adaptors

Tube type (mL)	Max. capacity per Rotor	Max. RCF (xg)	Adaptor Cat. No.
250	4	3,080	GAS-250(r250)
85 + 15	8 + 8	3,071	GAM-85-2(r250)
50 conical(Skirt)	16	3,145	GAM-sc50(r250)
50 conical	12	3,107	GAM-c50-3(r250)
25 conical	12	3,107	GAM-c50-3(r250)
50	16	3,095	GAM-50-4(r250)
15 conical	36	3,107	GAM-c15-9(r250)
15	48	3,095	GAM-15-12(r250)
14	24	3,095	GAM-15-12(r250)
Φ16 x 100 mm VT	48	3,095	GAM-15-12(r250)
Φ13 x 100 mm VT	48	3,095	GAM-5-12(r250)
Φ13 x 75 mm VT	48	3,095	GAM-5-12(r250)
15 / 2.0	80	3,045	GAM-m2.0-20(r250)

Swing-out Rotor  
**GRS-G-250-4**

- Capacity : 4 Buckets
- Max. RPM : 5,000
- Max. RCF : 5,394 xg



250 mL Bucket

**GLB-250-250**

- Capacity: 250 mL bottle or 1EA adaptor
- Max. RPM : 5,000
- Max. RCF : 5,394 xg
- Hole bottom type : Flat



**Adaptors**

Tube type (mL)	Max. capacity per Rotor	Max. RCF (xg)	Adaptor Cat. No.
250 conical	4	5,352	GAS-c250(250)
100	4	5,255	GAS-100(250)
85	4	5,255	GAS-85(250)
50 conical(Skirted)	4	5,255	GAS-sc50(250)
50 conical	4	5,394	GAS-c50(250)
50	8	5,255	GAM-50-2(250)
30	12	5,255	GAM-30-3(250)
25 conical	4	5,394	GAS-c25(250)
15 conical	16	5,338	GAM-c15-4 (250)
15	16	5,311	GAM-15-4(250)
Φ16 x 100 mm VT	16	5,311	GAM-10-7(250)
Φ13 x 75~100 mm VT	32	5,311	GAM-7-8(250)
5 conical	16	5,338	GAM-c5-4(250)
1.5 / 2.0	36	5,311	GAM-m2.0-9(250)

# OT-1696R II

## Multi-purpose Centrifuge

The OT-1696R II is a Extended throughput multi-purpose, Refrigerated centrifuge for swing out capacity of 4 x 1,000 mL buckets and High speed Fixed angle rotors up to 16,000 RPM



### Features

- Bio-seal (Public Health England Porton Down) certified Click-seal type buckets for aerosol tight operation of harmful samples
- Automatic rpm/rcf conversion
- Compressor-off function when lid is open minimizes unnecessary cooling and frosting.
- Temperature range from -11°C to 40°C
- 'Fast cool' function, R.T. to 4°C in 10 minutes for fast start up of cooled samples
- Selectable time mode of "at set SPEED" for counting running time only when reached the set speed
- A separate "PULSE" key for quick spin
- Intuitive control interface with numeric input buttons allows easy setting and editing of running conditions.
- Key lock function helps the set parameters secured during operation.
- Lid drop protection design allows easiness and safety when loading or unloading samples.

### Technical Specifications

OT-1696R II	
Max. RPM / Fixed angle	16,000 rpm
Max. RPM / Swing-out	5,000 rpm
Max. RCF / Fixed angle	27,991 xg
Max. RCF / Swing-out	5,394 xg
Max. capacity / Fixed angle	6 x 250 mL
Max. capacity / Swing-out	4 x 1,000 mL
Settable Min. RPM	300
RCF/RPM conversion	Yes
Temperature range (°C)	-11°C ~ 40°C
FAST cool button	Yes
Key lock function	Yes
Time control	Pulse, Timed < 10 hr or continuous
Time counting	Selectable, At Set Speed Or From Starting
Cat. No	OT-1696R II

## Fixed Angle Rotor GRF-B-250-6

- Capacity : 6 x 250 mL + 6 x 15 mL
- Max. RPM : 8,000
- Max. RCF : 9,588 xg



### Adaptors

Tube type (mL)	Max. capacity per Rotor	Max. RCF (xg)	Adaptor Cat. No.	Tube type (mL)	Max. capacity per Rotor	Max. RCF (xg)	Adaptor Cat. No.
100	6	8,586	GAS-100(250)	25 conical	6	8,228	GAS-c25(250)
85	6	8,443	GAS-85(250)	15 conical	24	9,051	GAM-c15-4 (250)
50 conical(Skirt)	6	8,622	GAS-sc50(250)	15	24	9,230	GAM-15-4(250)
50 conical	6	8,193	GAS-c50(250)	Φ16 x 100 mm VT	42	9,373	GAM-10-7(250)
50	12	8,264	GAM-50-2(250)	Φ13 x 75~100mm VT	48	9,373	GAM-7-8(250)
30	18	9,159	GAM-30-3(250)	5 conical	24	9,051	GAM-c5-4(250)
				1.5 / 2.0	54	9,230	GAM-m2.0-9(250)

## Fixed Angle Rotor GRF-B-85-6

- Capacity : 6 x 85 mL
- Max. RPM : 12,000
- Max. RCF : 16,019 xg



### Adaptors

Tube type (mL)	Max. RCF (xg)	Adaptor Cat. No.
50 conical	14,731	GAS-c50(85)
50	15,053	GAS-50(85)
30	14,843	GAS-30(85)
25 conical	13,024	GAS-c25(85)
15 conical	14,570	GAS-c15(85)
15	14,843	GAS-15(85)

## Fixed Angle Rotor GRF-B-50-8

- Capacity : 8 x 50 mL
- Max. RPM : 15,000
- Max. RCF : 25,910 xg



### Adaptors

Tube type (mL)	Max. RCF (xg)	Adaptor Cat. No.
30	24,275	GAS-30(50)
25 conical	20,376	GAS-c25(50)
15 conical	24,149	GAS-c15(50)
15	23,520	GAS-15(50)

### Fixed Angle Rotor GRF-B-c50-8

- Capacity : 8 x 50 mL Conical
- Max. RPM : 13,000
- Max. RCF : 20,784 xg

#### Adaptors

Tube type (mL)	Max. RCF (xg)	Adaptor Cat. No.
50	20,273	GAS-50(c50)
30	20,103	GAS-30(c50)
25 conical	17,779	GAS-c25(c50)
15 conical	19,877	GAS-c15(c50)



### Fixed Angle Rotor GRF-B-c15-12

- Capacity : 12 x 15 mL Conical
- Max. RPM : 15,000
- Max. RCF : 25,910 xg

#### Adaptors

Tube type (mL)	Max. RCF (xg)	Adaptor Cat. No.
5 conical	19,067	GAS-c5(c15)



### Fixed Angle Rotor GRF-B-m5.0-20

- Capacity : 20 x 5.0 mL
- Max. RPM : 13,500
- Max. RCF : 22,209 xg



### Fixed Angle Rotor GRF-B-m2.0-48

- Capacity : 48 x 1.5/2.0 mL
- Max. RPM : 16,000
- Max. RCF : 27,991 xg

#### Adaptors

Tube type (mL)	Max. RCF (xg)	Adaptor Cat. No.
0.5	25,043	GAS-m0.5(2)
0.2	23,040	GAS-m0.2(2)



## Swing-out Rotor GRS-B-1000-4

- Capacity : 4 Buckets
- Max. RPM : 3,700
- Max. RCF : 3,337 xg



1,000 mL High-capacity Bucket

### GLB-h1000-1000

- Capacity: 1EA adaptor
- Max. RPM : 3,700
- Max. RCF : 3,092 xg
- Hole bottom type : Flat

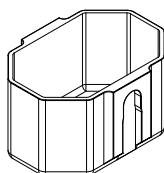

#### Adaptors

Tube type (mL)	Max. capacity per Rotor	Max. RCF (xg)	Adaptor Cat. No.
250	8	3,030	GAM-250-2(h1000)
50 conical	52	3,069	GAM-c50-13(h1000)
50	52	2,985	GAM-50-13(h1000)
15 conical	116	3,076	GAM-c15-29(h1000)
15	116	2,908	GAM-15-29(h1000)

Tube type (mL)	Max. capacity per Rotor	Max. RCF (xg)	Adaptor Cat. No.
14	72	2,916	GAM-10-38(h1000)
Φ16 x 100 mm VT	152	2,916	GAM-10-38(h1000)
Φ13 x 100 mm VT	192	2,916	GAM-5-48(h1000)
Φ13 x 75 mm VT	192	2,916	GAM-5-48(h1000)

1,000 mL Bio-safe, Rectangular Bucket with Click-Seal Cap

### GLBB- br1000-1000

- Capacity: 1EA adaptor
- Max. RPM : 3,700
- Max. RCF : 3,107 xg
- Hole bottom type : Flat

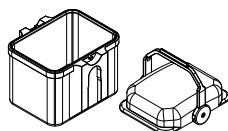

1,000 mL Bio-safe, Round Bucket with Click-Seal Cap

### GLB-h1000-1000

- Capacity : 1,000 mL or 750 mL bottle or 1EA adaptor
- Max. RPM : 3,700
- Max. RCF : 3,337 xg
- Hole bottom type : Flat

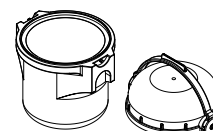

#### Adaptors

Tube type (mL)	Max. capacity per Rotor	Max. RCF (xg)	Adaptor Cat. No.
MTP / DWP	24 / 8	3,030	GLP-mw-r1000
50	40	3,061	GAM-50-10(br1000)
50 conical	32	3,084	GAM-c50-8(br1000)
25 conical	32	3,084	GAM-c50-8(br1000)
15 conical	72	3,084	GAM-c15-18(br1000)
5	72	3,084	GAM-c15-18(br1000)
15	80	3,076	GAM-15-20(br1000)
Φ16 x 100 mm VT	140	3,030	GAM-10-35(br1000)
Φ13 x 100 mm VT	160	2,992	GAM-5-40(br1000)
Φ13 x 75 mm VT	160	2,992	GAM-5-40(br1000)

#### Adaptors

Tube type (mL)	Max. capacity per Rotor	Max. RCF (xg)	Adaptor Cat. No.
500	4	3,283	GAS-500(750)
500 conical	4	3,321	GAS-c500(750)
250 conical	4	3,291	GAS-c250(750)
250	4	3,275	GAS-250(750)
50 conical	20	3,306	GAM-c50-5(750)
50	28	3,275	GAM-50-7(750)
15 conical	56	3,306	GAM-c15-14(750)
5	40	3,306	GAM-c15-14(750)
15	76	3,275	GAM-15-19(750)
14	28	3,275	GAM-15-19(750)
Φ16 x 100 mm VT	84	3,275	GAM-10-21(750)
Φ13 x 100 mm VT	96	3,275	GAM-5-24(750)
Φ13 x 75 mm VT	96	3,275	GAM-5-24(750)

## Swing-out Rotor GRS-B-750-4

- Capacity : 4 Buckets
- Max. RPM : 4,600
- Max. RCF : 4,850 xg



750 mL Bio-safe, Round Bucket with Click-Seal Cap

### GLBB-b750-750B

- Capacity: 750mL bottle or 1EA adaptor
- Max. RPM : 4,600
- Max. RCF : 4,850 xg
- Hole bottom type : Flat

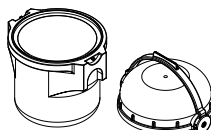

Bio-safe, Rectangular Bucket with Click-Seal Cap for Microplates

### GLBB-mw-750B

- Capacity: 4 x MTP / 1 x DWP
- Max. RPM : 4,600
- Max. RCF : 4,033 xg

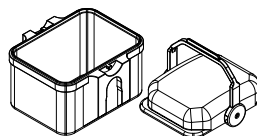

### Adaptors

Tube type (mL)	Max. capacity per Rotor	Max. RCF (xg)	Adaptor Cat. No.
500	4	4,767	GAS-500(750)
500 conical	4	4,826	GAS-c500(750)
250 conical	4	4,779	GAS-c250(750)
250	4	4,755	GAS-250(750)
50 conical	20	4,805	GAM-c50-5(750)
50	28	4,755	GAM-50-7(750)
15 conical	56	4,802	GAM-c15-14(750)
5	40	4,802	GAM-c15-14(750)
15	76	4,755	GAM-15-19(750)
14	28	4,755	GAM-15-19(750)
Φ16 x 100 mm VT	84	4,755	GAM-10-21(750)
Φ13 x 100 mm VT	96	4,755	GAM-5-24(750)
Φ13 x 75 mm VT	96	4,755	GAM-5-24(750)

## Swing-out Rotor GRS-B-250-4

- Capacity : 4 Buckets
- Max. RPM : 5,000
- Max. RCF : 5,394 xg



250 mL Round Bucket

### GLB-250-250

- Capacity: 250 mL bottle or 1EA adaptor
- Max. RPM : 5,000
- Max. RCF : 5,394 xg
- Hole bottom type : Flat



### Adaptors

Tube type (mL)	Max. capacity per Rotor	Max. RCF (xg)	Adaptor Cat. No.
250 mL conical	4	5,352	GAS-c250(250)
100	4	5,255	GAS-100(250)
85	4	5,255	GAS-85(250)
50 conical(Skirted)	4	5,255	GAS-sc50(250)
50 conical	4	5,394	GAS-c50(250)
50	8	5,255	GAM-50-2(250)
30	12	5,255	GAM-30-3(250)
25 conical	4	5,394	GAS-c25(250)
15 conical	16	5,338	GAM-c15-4 (250)
15	16	5,311	GAM-15-4(250)
Φ16x 100 mm VT	16	5,311	GAM-10-7(250)
Φ13x 75~100 mm VT	32	5,311	GAM-7-8(250)
5	16	5,338	GAM-c5-4(250)
1.5 / 2.0	36	5,311	GAM-m2.0-9(250)

# High Speed & Capacity, Floor standing Centrifuges

**OT-S12R**



**OT-S22R**



# OT-S12R / OT-S22R

## High Speed, High Capacity, Floor standing Centrifuges

The OT-S12R and OT-S22R are high-throughput, floor-standing refrigerated centrifuges designed for professional-grade high-speed separation. The OT-S12R supports large-volume processing of up to six 1 L bottles, while the OT-S22R offers superior high-speed performance, reaching up to 22,000 RPM (52,001 xg) for various laboratory applications.



### Features

- A dedicated large indication lamp enabling efficient and accurate operational monitoring from a distance
- 7" touchscreen display for intuitive UI showing simultaneous display of all operational parameters of set and actual figures
- Automatic rpm/rcf conversion
- Compressor-off function when lid is open minimizes unnecessary cooling and frosting.
- Temperature range from -10°C to 40°C
- 'Fast cool' function, R.T. to 4°C for fast start up of cooled samples
- Selectable time mode of "at set SPEED" for counting running time only when reached the set speed
- A separate "PULSE" key for quick spin
- Intuitive control interface with numeric input buttons allows easy setting and editing of running conditions.
- Key lock function helps the set parameters secured during operation.
- Lid drop protection design allows easiness and safety when loading or unloading samples.

### Technical Specifications

Model Name	OT-S12R	OT-S22R
Max. RPM / Fixed angle	12,000 rpm	22,000 rpm
Max. RCF / Fixed angle	22,265 xg	52,001 xg
Max. capacity / Fixed angle	6 x 1,000 mL	4 x 1,000 mL
Settable Min. RPM	400	
RCF/RPM conversion	Yes	
Temperature range (°C)	-10°C to 40°C	
Time control	Pulse, Timed < 10 hr or continuous	
Time counting	Selectable, At Set Speed Or From Starting	
Noise level (dependent on rotor)	≤ 65 dB	
ACC/DEC ramps	10/10 steps	10/11 steps
Program memory	100	
Rotor identification	Automatic	
Imbalance cutout	Automatic	
Safety lid lock	Automatic	
Motorized door open & close	Automatic	
Power supply (V/Hz)	220-230V~, 50/60Hz (110V 60Hz optional)	220-230V, 60Hz (220~230V, 50Hz, 110V 60Hz optional)
Power Requirement (VA)	3.0 kW	4.6 kVA
Dimension (W x D x H, mm)	668 x 800 x 891/805	681 x 795 x 920
Weight without rotor	230 kg	247 kg
Cat. No.	OT-S12R	OT-S22R

Fixed Angle Rotor

**A1000-6T** **OT-S12R Only**

- Capacity : 6 x 1,000 mL
- Max. RPM : 7,000
- Max. RCF : 10,962

Adaptors

Tube type (mL)	Max. RCF (xg)	Adaptor Cat. No.
500	10,184	TR500(1000)
250	9,127	TR250(1000)



Fixed Angle Rotor

**A1000-4T**

- Capacity : 4 x 1,000 mL
- Max. RPM : 8,000
- Max. RCF : 12,157

Adaptors

Tube type (mL)	Max. RCF (xg)	Adaptor Cat. No.
500	11,141	TR500(1000)
250	9,760	TR250(1000)



Fixed Angle Rotor

**A500-6**

- Capacity : 6 x 500 mL
- Max. RPM : 10,000
- Max. RCF : 17,743

Adaptors

Tube type (mL)	Max. RCF (xg)		Adaptor Cat. No.
	OT-S12R	OT-S22R	
250	15,540	12,588	TR250(A500)



Fixed Angle Rotor

## A250-6

- Capacity : 6 x 250 mL
- Max. RPM : 12,000
- Max. RCF : 22,265 xg



Adaptors

Tube type (mL)	Max. capacity per Rotor	Max. RCF (xg)	Adaptor Cat. No.
100	6	20,044	TR100(250)
85	6	19,722	TR85(250)
50 conical(Skirt)	6	20,124	TR50sc(250)
50 conical	6	19,158	TR50c(250)
50	12	19,319	TR50-2(250)
30	18	21,331	TR30-3(250)
25 conical	6	19,319	TR25c(250)

Tube type (mL)	Max. capacity per Rotor	Max. RCF (xg)	Adaptor Cat. No.
15 conical	24	21,090	TR15c-4 (250)
15	24	21,492	TR15-4(250)
Φ16 x 100 mm VT	42	21,492	TR10-7(250)
Φ13 x 75-100 mm VT	48	21,814	TR7-8(250)
5 conical	24	21,090	TR5c-4(250)
1.5 / 2.0	54	21,734	TR2.0-9(250)

Fixed Angle Rotor

## A85-6 **OT-S22R Only**

- Capacity : 6 x 85 mL
- Max. RPM : 20,000
- Max. RCF : 43,647 xg



Adaptors

Tube type (mL)	Max. RCF (xg)	Adaptor Cat. No.
50 conical	41,590	TR50c(85)
50	41,545	TR50(85)
30	40,964	TR30(85)
25 conical	35,910	TR25c(85)
15 conical	39,890	TR15c(85)
15	39,801	TR15(85)

Fixed Angle Rotor

## A50c-8 **OT-S22R Only**

- Capacity : 8 x 50 mL Conical
- Max. RPM : 15,000
- Max. RCF : 27,796 xg



Adaptors

Tube type (mL)	Max. RCF (xg)	Adaptor Cat. No.
50	27,167	TR50(50c)
30	26,916	TR30(50c)
25 conical	23,897	TR25c(50c)
15 conical	26,589	TR15c(50c)

Fixed Angle Rotor

**A50-8** **OT-S22R Only**



Adaptors

Tube type (mL)	Max. RCF (xg)	Adaptor Cat. No.
30	41,679	TR30(50)
25 conical	35,239	TR25c(50)
15 conical	41,992	TR15c(50)
15	41,500	TR15(50)

Fixed Angle Rotor

**A50-6** **OT-S22R Only**

- Capacity : 6 x 50 mL
- Max. RPM : 22,000
- Max. RCF : 52,001 xg



Adaptors

Tube type (mL)	Max. RCF (xg)	Adaptor Cat. No.
15 conical	49,241	TR15c(50)
15	48,646	TR15(50)

Fixed Angle Rotor

**A15c-12** **OT-S22R Only**



Fixed Angle Rotor

**A15S-12** **OT-S22R Only**

- Capacity : 12 x 15 mL
- Max. RPM : 22,000
- Max. RCF : 52,001 xg



Fixed Angle Rotor

**A10-12** **OT-S22R Only**

- Capacity : 12 x 10 mL
- Max. RPM : 22,000
- Max. RCF : 46,049 xg



Fixed Angle Rotor

**A2.0-36** **OT-S22R Only**

- Capacity : 36 x 1.5 / 2.0 mL
- Max. RPM : 18,000
- Max. RCF : 41,910 xg



Adaptors

Tube type (mL)	Max. RCF (xg)	Adaptor Cat. No.
0.5	40,208	TR0.5
0.2	36,223	TR0.2



# Low Speed Centrifuges

**OT-T04**



**OT-T04B**



**OT-T05R**



# OT-T04

## Low Speed Centrifuge

The OT-T04 is a basic Air-ventilated clinical centrifuge for 12 x bloodtubes.



### Features

- Supplied with an Angle rotor for 12 x bloodtubes or 6 x 15mL tubes
- Automatic rpm/rcf conversion
- Automatic lid opening function, at the completion of a run, serves to both indicate the end of the process and to prevent sample warming
- A separate "PULSE" key for quick spin
- Lid drop protection design allows easiness and safety when loading or unloading samples.

### Technical Specifications

OT-T04	
Max. RPM / Fixed angle	4,000 rpm
Max. RCF / Fixed angle	2,075 x g
Max. capacity / Fixed angle	12 x vacuum tube
Settable Min. RPM	500
RCF/RPM conversion	Yes
Time control	Pulse, timed < 100 min or continuous
Time counting	From Starting
Noise level (dependent on rotor)	< 52 dB
Program memory	30
Imbalance cutout	Yes
Safety lid lock	Yes
Power supply (V/Hz)	210~240 V, 50/60Hz (110V 60Hz optional)
Power Requirement (VA)	140VA
Dimension (W x D x H, mm)	296 x 408 x 213
Weight without rotor	15 kg
Cat. No.	OT-T04

### Fixed Angle Rotor AO-15/10-12

- Capacity : 12 x Vacuum tube or 6 x 15 mL
- Max. RPM : 4,000
- Max. RCF : 2,075
- Supplied with centrifuge



### Adaptors

Tube type (mL)	Max. RCF (xg)	Adaptor Cat. No.
14	1,869	TR14(15f)
5 conical	1,458	TR5c(15f)
Φ13 x 100 mm VT	1,986	TR5(15f)
Φ13 x 75 mm VT	1,708	TR3(15f)



# OT-T04B / OT-T05R

## Low Speed Centrifuges

The OT-T04B and OT-T05R are clinical centrifuges designed for general laboratory use, both accommodating up to 32 blood tubes per run. While the OT-T04B features an air-ventilated system for standard applications, the OT-T05R offers a refrigerated function to ensure temperature stability for sensitive samples.



## Features

- Certified Bio-seal buckets (Public Health England Porton Down) are available as options to ensure aerosol-tight operation for hazardous samples.
- Automatic RPM/RCF conversion and a “Pulse” key for quick spins facilitate efficient sample processing.
- Intuitive control interface with numeric input buttons allows for effortless setting and modification of running conditions.
- Key lock function ensures that set parameters remain secure during operation.
- Lid drop protection design provides enhanced safety and convenience during sample loading and unloading.
- Selectable “At set speed” time mode counts the run time only once the target speed is reached.
- Automatic lid opening at the end of a run serves to signal process completion and prevent sample warming. (T04B)
- Integrated cooling system offers a temperature range from -10°C to 40°C. (T05R)
- “Fast Cool” function chills the chamber from room temperature to 4°C within 5 minutes for rapid startup. (T05R)
- Compressor-off function when the lid is open minimizes unnecessary cooling and frosting. (T05R)

## Technical Specifications

Model Name	OT-T04B	OT-T05R
Max. RPM / Fixed angle	4,000 rpm	5,000 rpm
Max. RPM / Swing-out	4,000 rpm	5,000 rpm
Max. RCF / Fixed angle	2,773 x g	3,983 x g
Max. RCF / Swing-out	2,774 x g	4,218 x g
Max. capacity / Fixed angle	10 x 50 mL	
Max. capacity / Swing-out	4 x 100 mL	
Settable Min. RPM	400	
RCF/RPM conversion	Yes	
Temperature range (°C)	-	-10°C to 40°C
FAST cool button	-	Yes
Key lock function	Yes	
Time control	Pulse, Timed < 10 hr or continuous	
Time counting	Selectable, at set speed or from starting	
Noise level (dependent on rotor)	< 60 dB	< 60 dB
ACC/DEC ramps	9/10 steps	9/10 steps
Program memory	100	100
Rotor identification	Manual	Automatic
Imbalance cutout	Yes	Yes
Safety lid lock	Yes	Yes
Power supply (V/Hz)	210~240 V, 50/60Hz (110V 60Hz optional)	
Power Requirement (VA)	340VA	900 VA
Dimension (W x D x H, mm)	375 x 506 x 265	584 x 554 x 313
Weight without rotor	25.7 kg	65.7 kg
Cat. No.	OT-T04B / OT-T05R	OT-T04B / OT-T05R

Angle Rotor

**AO-50-10** **OT-T04B** | **A-50-10** **OT-T05R**

- Capacity : 10 x 50 mL or 50 mL Conical
- Max. RPM / RCF  
T04B : 4,000 / 2,549 xg  
T05R : 5,000 / 3,983 xg



Adaptors

Tube type (mL)	Max. RCF (xg)		Adaptor Cat. No.
	OT-T04B	OT-T05R	
50 conical	2,549	3,983	TR50c(50f)
30	2,415	3,773	TR30(50f)
25 conical	2,057	3,214	TR25c(50f)
15 conical	2,538	3,966	TR15(50f)
14	2,538	3,966	TR14(50f)

Angle Rotor

**AO-c50-10** **OT-T04B** | **A-c50-10** **OT-T05R**

- Capacity : 10 x 50 mL or 50 mL Conical
- Max. RPM / RCF  
T04B : 4,000 / 2,549 xg  
T05R : 5,000 / 3,983 xg



Adaptors

Tube type (mL)	Max. RCF (xg)		Adaptor Cat. No.
	OT-T04B	OT-T05R	
50	2,435	3,804	TR50(50c)
30	2,424	3,787	TR30(50c)
25 conical	2,057	3,214	TR25c(50c)
15 conical	2,497	3,902	TR15c(50c)

Angle Rotor

**AO-15-24** **OT-T04B** | **A-15-24** **OT-T05R**

- Capacity : 24 x Vacuum tube or 15 mL
- Max. RPM / RCF  
T04B : 4,000 / 2,773 xg  
T05R : 4,500 / 3,509 xg



Adaptors

Tube type (mL)	Max. RCF (xg)		Adaptor Cat. No.
	OT-T04B	OT-T05R	
14	2,549	3,226	TR14(15f)
5 conical	2,170	2,746	TR5c(15f)
Φ13 x 100 mm VT	2,733	3,459	TR5(15f)
Φ13 x 75 mm VT	2,367	2,995	TR3(15f)

Swing-out Rotor

**SO-100-4** **OT-T04B** | **S-100-4** **OT-T05R**

- Capacity : 4 x Buckets
- Max. RPM / RCF  
T04B : 4,000 / 2,774 xg  
T05R : 4,500 / 3,511 xg

100 mL Bio-safe Bucket with a Cap

**BB100b-100**

- Max. RPM / RCF  
OT-T04B : 4,000 / 2,774 xg  
OT-T05R : 4,500 / 3,511 xg
- Hole bottom type : Flat

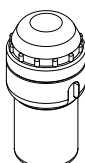

Adaptors

Tube type (mL)	Max. tube capacity per rotor	Max. RCF (xg)		Adaptor Cat. No.
		OT-T04B	OT-T05R	
100 *	4	2,685	3,398	TR100(100)
85	4	2,739	3,466	TR85(100)
50 conical(Skirt)	4	2,721	3,443	TR50sc(100)
50 conical	4	2,773	3,515	TR50c(100)
25 conical	4	2,164	2,744	
50	4	2,739	3,466	TR50(100)
30	4	2,739	3,466	TR30(100)

Tube type (mL)	Max. tube capacity per rotor	Max. RCF (xg)		Adaptor Cat. No.
		OT-T04B	OT-T05R	
15 conical *	12	2,744	3,479	TR15c-3(100)
5 conical *	12	1,760	2,231	
15 conical	4	2,774	3,511	TR15c(100)
15 *	12	2,721	3,443	TR15-3(100)
Φ16 x 100 mm VT	20	2,685	3,398	TR10-5(100)
Φ13 x 75~100 mm VT	20	2,685	3,398	TR7-5(100)
1.5 / 2.0	24	2,685	3,398	TR2-6(100)

\* Cannot use cap sealing

Dual 50 mL Conical Bucket

**GLB-dc50-100**

- Max. RPM / RCF  
OT-T04B : 4,000 / 2,774 xg  
OT-T05R : 4,500 / 3,511 xg
- Hole bottom type : Conical

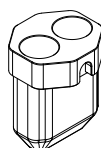

Adaptors

Tube type (mL)	Max. tube capacity per rotor	Max. RCF (xg)		Adaptor Cat. No.
		OT-T04B	OT-T05R	
50	8	2,588	3,276	TR50(50c)
30	8	2,592	3,280	TR30(50c)
25 conical	8	2,102	2,660	TR25c(50c)
15 conical	8	2,774	3,511	TR15c(50c)

Dual 15 mL Conical Bio-safe Bucket with a Cap

**BBd15cb-100**

- Max. RPM / RCF  
OT-T04B : 4,000 / 2,774 xg  
OT-T05R : 4,500 / 3,511 xg
- Hole bottom type : Conical

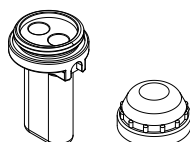

Adaptors

Tube type (mL)	Max. tube capacity per rotor	Max. RCF (xg)		Adaptor Cat. No.
		OT-T04B	OT-T05R	
14	8	2,352	2,977	TR14(15c)
5 conical	8	1,746	2,210	TR5c(15c)

8 x Vacuum tube Bucket

**B15-8-100**

- Max. RPM / RCF  
OT-T04B : 4,000 / 2,719 xg  
OT-T05R : 4,500 / 3,441 xg
- Hole bottom type : Flat

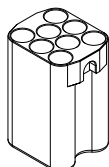

Adaptors

Tube type (mL)	Max. tube capacity per rotor	Max. RCF (xg)		Adaptor Cat. No.
		OT-T04B	OT-T05R	
14	32	2,513	3,181	TR14(15f)
5 conical	32	2,003	2,536	TR5c(15f)
Φ13 x 100 mm VT	32	2,719	3,441	TR5(15f)
Φ13 x 75 mm VT	32	2,236	2,830	TR3(15f)

Swing-out Rotor

**SO-50-4** **OT-T04B** | **S-50-4** **OT-T05R**

- Capacity : 4 x Buckets
- Max. RPM / RCF  
OT-T04B : 4,000 / 2,700 xg  
OT-T05R : 5,000 / 4,218 xg



50 mL Bucket

**B50-50**

- Max. RPM / RCF  
OT-T04B : 4,000 / 2,700 xg  
OT-T05R : 5,000 / 4,218 xg
- Hole bottom type : Flat

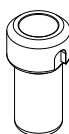

Adaptors

Tube type (mL)	Max. tube capacity per rotor	Max. RCF (xg)		Adaptor Cat. No.
		OT-T04B	OT-T05R	
50 conical	4	2,700	4,218	TR50c(50f)
30	4	2,583	4,036	TR30(50f)
25 conical	4	2,107	3,293	TR25c(50f)
15 conical	4	2,700	4,218	TR15(50f)
14	4	2,700	4,218	TR14(50f)

50 mL Conical Bucket

**B50c-50**

- Max. RPM / RCF  
OT-T04B : 4,000 / 2,700 xg  
OT-T05R : 5,000 / 4,218 xg
- Hole bottom type : Conical

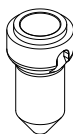

Adaptors

Tube type (mL)	Max. tube capacity per rotor	Max. RCF (xg)		Adaptor Cat. No.
		OT-T04B	OT-T05R	
50	4	2,513	3,927	TR50(50c)
30	4	2,517	3,933	TR30(50c)
25 conical	4	2,027	3,167	TR25c(50c)
15 conical	4	2,700	4,218	TR15c(50c)
14	4	2,700	4,218	TR14(50f)

Dual 15 mL Bucket

**Bd15-50**

- Max. RPM / RCF  
OT-T04B : 4,000 / 2,700 xg  
OT-T05R : 5,000 / 4,218 xg
- Hole bottom type : Round

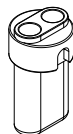

Dual 15 mL Conical Bucket

**Bd15c-50**

- Max. RPM / RCF  
4,000 / 2,700 xg  
OT-T04B : 4,000 / 2,700 xg  
OT-T05R : 5,000 / 4,218 xg
- Hole bottom type : Conical

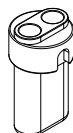

Adaptors

Tube type (mL)	Max. tube capacity per rotor	Max. RCF (xg)		Adaptor Cat. No.
		OT-T04B	OT-T05R	
14	8	2,277	3,558	TR14(15c)
5 conical	8	1,671	2,611	TR5c(15c)

Swing-out Rotor

**SO-15-6** **OT-T04B** | **S-15-6** **OT-T05R**

- Capacity : 6 x Buckets
- Max. RPM / RCF  
T04B : 4,000 / 2,737 xg  
T05R : 4,400 / 3,312 xg



Dual 15 mL Bucket

**Bd15-15**

- Max. RPM / RCF  
T04B : 4,000 / 2,737 xg  
T05R : 4,400 / 3,312 xg
- Hole bottom type : Flat

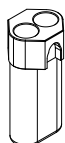

Adaptors

Tube type (mL)	Max. tube capacity per rotor	Max. RCF (xg)		Adaptor Cat. No.
		OT-T04B	OT-T05R	
Φ13 x 100 mm VT	12	2,737	3,312	TR5(15f)
Φ13 x 75 mm VT	12	2,164	2,727	TR3(15f)

Swing-out Rotor

**SO-mw-2** **OT-T04B** | **S-mw-2** **OT-T05R**

- Capacity : 2 x Microplates
- Max. RPM / RCF : 4,000 / 2,000 xg





# Clinical Use Centrifuges IVDR



# GZ-416

## Low Speed Centrifuge

IVDR Certified Low Speed Centrifuge for Clinical Use



Bio



### Features

- Compact, low speed centrifuges with 32 x blood tube capacity for fractionation of blood samples.
- 12 x 15 mL and 8 x 50 mL capacity for simple precipitation of biological samples and cell culture.
- Bio-Safe buckets ensure safe centrifugation of hazardous samples.
- A separate button for "Soft" start/stop function to achieve very gentle acceleration and deceleration.
- Furnished with unique air flow design and anti-vibration structure to minimize heat and noise.
- CE IVDR version.

### Technical Specifications

Max. RPM/PCF for Fixed Angle	4,000 rpm / 2,700 xg
Max. RPM/PCF for Swing-out	4,000 rpm / 2,826 xg
Max. Capacity for Fixed Angle	16 x 15 mL, 10 x 50 mL
Max. Capacity for Swing-out	4 x 100 mL, 4 x 8 Vacuum tube, 2 x 2 MTPs
Time control	Timed <100 min or continuous
Acc. time to Max. Speed	≤20 sec
Dec. time from Max. Speed	≤25 sec
Noise level (dependent on rotor)	≤52 dB
RCF/RPM conversion	Yes
Program Memory	10
Power Supply	AC 230V, 50Hz (AC 220-230V, 60/50Hz; 110V optional)
Power Requirement	340 VA
Dimension (W x D x H)	375 x 480 x 260 mm
Net Weight	19.5 kg
CE MARK	Yes
Cat. No.	GZ-416(IVD)



## Angle Rotor

**GRA-S-50-10**

- Capacity : 10 x 50 mL or 50 mL Conical
- Max. RPM / RCF  
4,000 / 2,549 xg



## Adaptors

Tube type (mL)	Max. RCF (xg)	Adaptor Cat. No.
50 conical	2,549	GAS-c50(f50)
30	2,415	GAS-30(f50)
25 conical	2,057	GAS-c25(f50)
15 conical	2,538	GAS-u15(f50)
14	2,538	GAS-u14(f50)

## Angle Rotor

**GRA-S-c50-10**

- Capacity : 10 x 50 mL or 50 mL Conical
- Max. RPM / RCF  
4,000 / 2,508 xg



## Adaptors

Tube type (mL)	Max. RCF (xg)	Adaptor Cat. No.
50	2,435	GAS-50(c50)
30	2,424	GAS-30(c50)
25 conical	2,057	GAS-c25(c50)
15 conical	2,497	GAS-c15(c50)

## Angle Rotor

**GRA-S-15-16**

- Capacity : 16 x Vacuum tube or 15ml
- Max. RPM / RCF  
4,000 / 2,700 xg



## Adaptors

Tube type (mL)	Max. RCF (xg)	Adaptor Cat. No.
14	2,494	GAS-14(f15)
5 conical	2,120	GAS-c5(f15)
Φ13 x 100 mm VT	2,612	GAS-5(f15)
Φ13 x 75 mm VT	2,397	GAS-3(f15)

## Swing-out Rotor GRS-S-100-4

- Capacity : 4 x Buckets
- Max. RPM / RCF  
4,000 / 2,774 xg

100 mL Bio-safe Bucket with a Cap

### GLBB-b100-100

- Max. RPM / RCF  
4,000 / 2,774 xg
- Hole bottom type : Flat

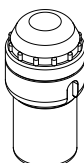

### Adaptors

Tube type (mL)	Max. tube capacity per rotor	Max. RCF (xg)	Adaptor Cat. No.
100 *	4	2.685	GAS-100(b100)
85	4	2.739	GAS-85(b100)
50 conical(Skirt)	4	2.721	GAS-sc50(b100)
50 conical	4	2.721	GAS-c50(b100)
25 conical	4	2.739	GAS-c50(b100)
50	4	2.739	GAS-50(b100)
30	4	2.739	GAS-30(b100)

\* Cannot use cap sealing

Tube type (mL)	Max. tube capacity per rotor	Max. RCF (xg)	Adaptor Cat. No.
15 conical *	12	2.774	GAM-c15-3(100)
5 conical *	12	1.969	GAM-c15-3(100)
15 conical	4	2.774	GAS-c15(b100)
15 *	12	2.721	GAM-15-3(100)
∅16 x 100 mm VT	20	2.685	GAM-10-5(b100)
∅13 x 75~100 mm VT	20	2.685	GAM-7-5(b100)
1.5 / 2.0	24	2.685	GAM-m2.0-6(b100)

Dual 50 mL Conical Bucket

### GLB-dc50-100

- Max. RPM / RCF  
4,000 / 2,774 xg
- Hole bottom type : Conical

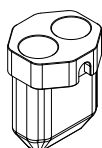

### Adaptors

Tube type (mL)	Max. tube capacity per rotor	Max. RCF (xg)	Adaptor Cat. No.
50	8	2,588	GAS-50(c50)
30	8	2,592	GAS-30(c50)
25 conical	8	2,102	GAS-c25(c50)
15 conical	8	2,774	GAS-c15(c50)

Dual 15 mL Conical Bio-safe Bucket with a Cap

### GLBB-bdc15-100

- Max. RPM / RCF  
4,000 / 2,774 xg
- Hole bottom type : Conical

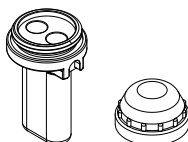

### Adaptors

Tube type (mL)	Max. tube capacity per rotor	Max. RCF (xg)	Adaptor Cat. No.
14	8	2,352	GAS-14(c15)
5 conical	8	1,746	GAS-c5(c15)

8 x Vacuum tube Bucket

### GLB-15-8-100

- Max. RPM / RCF  
4,000 / 2,719 xg
- Hole bottom type : Flat

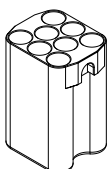

### Adaptors

Tube type (mL)	Max. tube capacity per rotor	Max. RCF (xg)	Adaptor Cat. No.
14	32	2,513	GAS-14(f15)
5 conical	32	2,003	GAS-c5(f15)
∅13 x 100 mm VT	32	2,719	GAS-5(f15)
∅13 x 75 mm VT	32	2,236	GAS-3(f15)

## Swing-out Rotor GRS-S-50-4

- Capacity : 4 x Buckets
- Max. RPM / RCF  
4,000 / 2,700 xg



50 mL Bucket

### GLB-50-50

- Max. RPM / RCF  
4,000 / 2,700 xg
- Hole bottom type : Flat

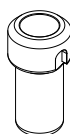

#### Adaptors

Tube type (mL)	Max. tube capacity per rotor	Max. RCF (xg)	Adaptor Cat. No.
50 conical	4	2,700	GAS-c50(f50)
30	4	2,583	GAS-30(f50)
25 conical	4	2,107	GAS-c25(f50)
15 conical	4	2,700	GAS-u15(f50)
14	4	2,700	GAS-u14(f50)

50 mL Conical Bucket

### GLB-c50-50

- Max. RPM / RCF  
4,000 / 2,700 xg
- Hole bottom type : Conical



#### Adaptors

Tube type (mL)	Max. tube capacity per rotor	Max. RCF (xg)		Adaptor Cat. No.
		T04B	T05R	
50	4	2,513	3,927	GAS-50(c50)
30	4	2,517	3,933	GAS-30(c50)
25 conical	4	2,027	3,167	GAS-c25(c50)
15 conical	4	2,700	4,218	GAS-c15(c50)

Dual 15 mL Bucket

### GLB-d15-50

- Max. RPM / RCF  
4,000 / 2,700 xg
- Hole bottom type : Round

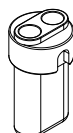

Dual 15 mL Conical Bucket

### GLB-dc15-50

- Max. RPM / RCF  
4,000 / 2,700 xg
- Hole bottom type : Conical

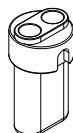

#### Adaptors

Tube type (mL)	Max. tube capacity per rotor	Max. RCF (xg)	Adaptor Cat. No.
14	8	2,277	GAS-14(c15)
5 conical	8	1,671	GAS-c5(c15)

## Swing-out Rotor GRS-S-15-6

- Capacity : 6 x Buckets
- Max. RPM / RCF  
4,000 / 2,737 xg



Dual 15 mL Bucket

### GLB-d15-15

- Max. RPM / RCF  
4,000 / 2,737 xg
- Hole bottom type : Flat

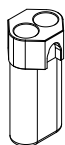

#### Adaptors

Tube type (mL)	Max. tube capacity per rotor	Max. RCF (xg)	Adaptor Cat. No.
∅13 x 100 mm VT	12	2,737	GAS-5(f15)
∅13 x 75 mm VT	12	2,164	GAS-3(f15)

## Swing-out Rotor GRS-S-mw-2

- Capacity : 2 x Microplates
- Max. RPM / RCF : 4,000 / 2,000 xg

